

FLOW CONTROL VALVES

AM3-FX-*

60 l/min - 32 MPa (320 bar)

1 DESCRIPTION

Stackable valve CETOP 3 with meter in control (referred to the hydraulic actuator). It is possible to control the lines A, B or AB simply turning the side screws.

On demand it is possible to have also the fine control option.

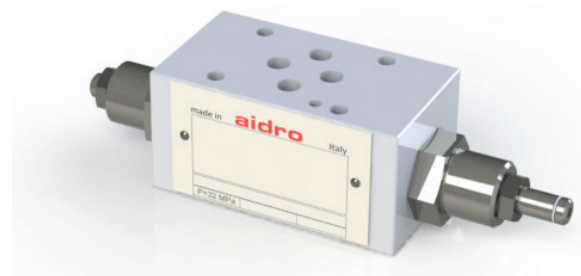

2 ORDERING CODE

(1)	(2)	(3)	(4)	(5)	(6)
AM3	-	FX	-	-	/ 10

(1) AM3: stackable valve CETOP 03 - Pressure 32 MPa (320 bar)

(2) FX: one way flow control valves with meter-out control (referred to the hydraulic actuator)

(3) Service lines where the controls operate:

- AB: controls on A and B. Fluid flows unrestricted from A1-> A and B1-> B and flow is controlled from A-> A1 and B-> B1
- A : flow is controlled from A-> A1, free on B
- B : flow is controlled from B-> B1; free on A

(4) Flow control characteristics for A-> A1 and B-> B1 and check valve opening pressure (Pm) for flow A1-> A and B1-> B

- no designation: standard control and Pm approx 0,04 MPa (0,4 bar)
- V: fine control
- 4: Pm approx 0,4 MPa (4 bar)

(5) Code reserved for option and variants

(6) Design number (progressive) of the valves

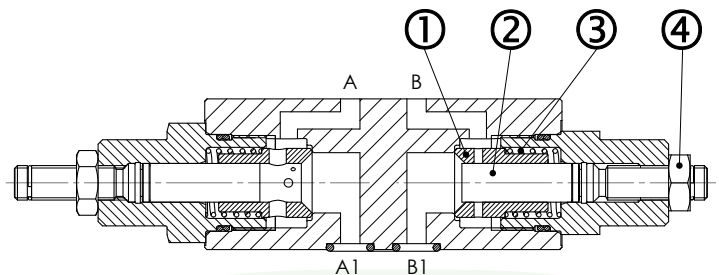
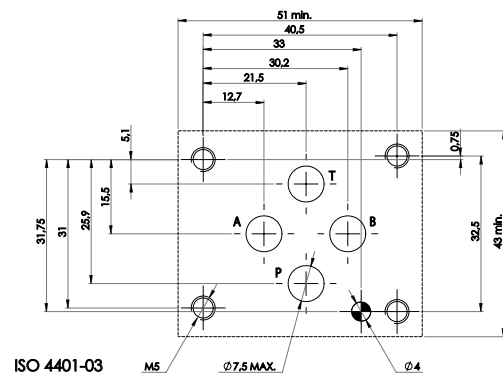

AM3-FX-AB

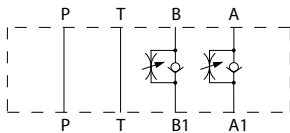

AM3-FX-A

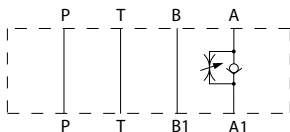

AM3-FX-B

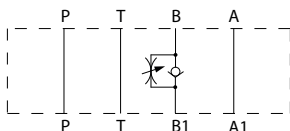

Fluids flows freely on P and T lines: on service lines A and/or B with controls, fluid flows from A-> A1 (and/or B-> B1) overcoming the force of spring 5 acting on sleeve 2; fluid flows from A1-> A (and/or B1->B) through orifices to sleeve 2 which is pushed against its seat; the throttling axis 4, which is shifted by screwing it and locked by its nut 3, partially obstructs the control orifices, thus making the flow rate entirely dependent upon the available pressure drop.

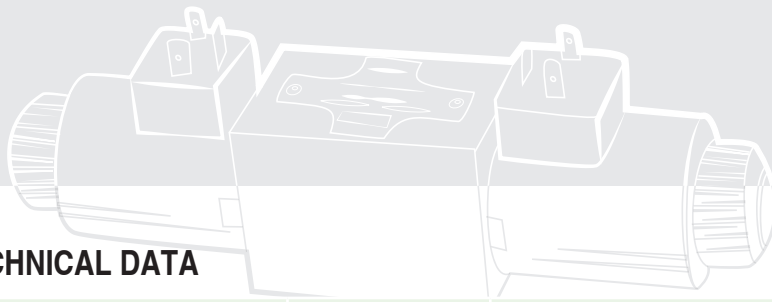

3 TECHNICAL DATA

Maximum nominal flow		Control of the flow:
Maximum rec. flow rate	60 l/min	The control is made by throttling from through variable orifices obtained on sleeve and partially obstructed by throttling axis. Depending on the various sleeve/axis combination, the control adjustment is:
Maximum nominal pressure	32 MPa (320 bar)	- (standard): orifices area is reduced from 100% (*) to 0% with 6 complete turns of the adjustment screw.
Pressure drops	see [4]	- V (fine): from 100% (**) to 0% with 5 complete turns of the adjustment screw.
Installation and dimensions	see [5]	(*) 100% approx Q=1 dm ³ /s (60 l/min) at p=2 MPa (20 bar)
Mass	approx 1,2 kg	(**) 100% approx Q=0,5 dm ³ /s (30 l/min) at p=2 MPa (20 bar)
		The axis is shifted to increase throttling by unlocking its nut and turning clock wise the adjustment screw.
		Suitable mechanical stops prevent dangerous manoeuvring.

4 TYPICAL DIAGRAMS

Typical p-Q curves for valves AM3-FX-* in standard configuration, with mineral oil at 36 cSt and at 50°C with throttling axis at full retraction.

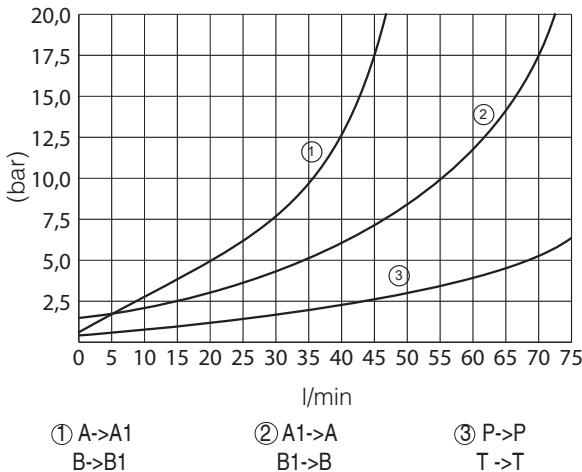

6 HYDRAULIC FLUIDS

Seals and materials used on standard valves AM3-* are fully compatible with hydraulic fluids of mineral oil base, upgraded with antifoaming and antioxidizing agents. The hydraulic fluid must be kept clean and filtered to ISO 4406 class 19/17/14, or better, and used in a recommended viscosity range from 10 cSt to 60 cSt.

5 INSTALLATION DIMENSIONS (mm)

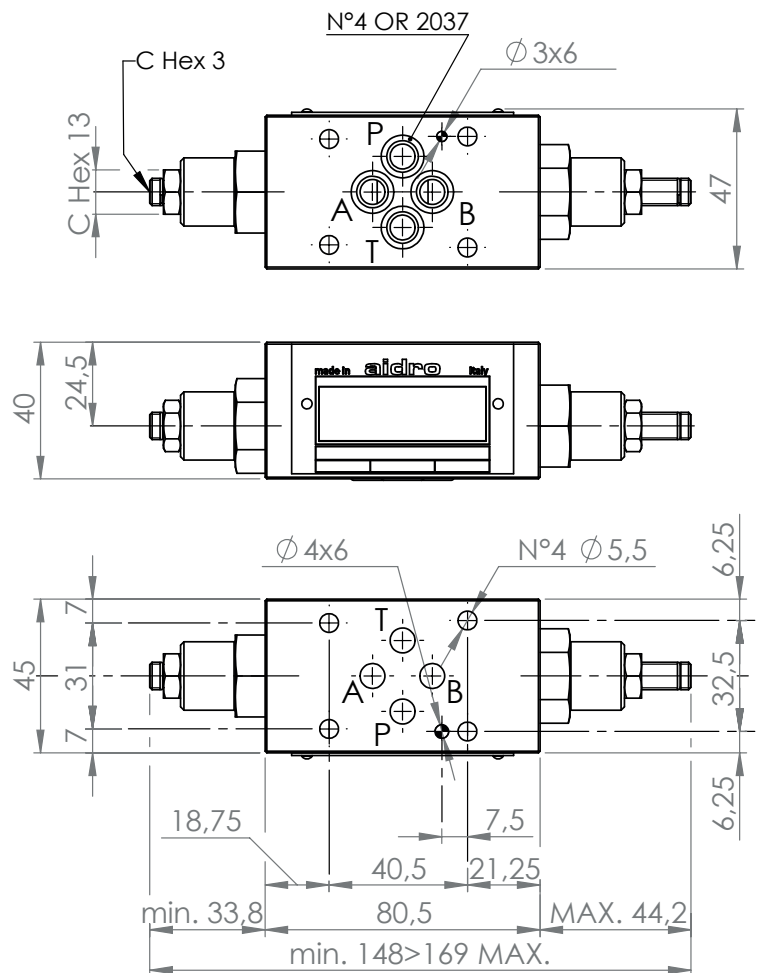

All stackable valves AM3-FX-* conform with ISO and CETOP specifications for mounting surface dimensions. Valves height 40 mm. Leakage between valve and mounting surface is prevented by the positive compression on their seats of 4 seals of OR type. All valves have on their "mounting" surface a ϕ 4 mm cylindrical hole and have on their "seals" surface a ϕ 3 mm cylindrical hole, conform with ISO and CETOP norms.